

**Datasheet**

Subject to technical alteration  
Issue date: 07.03.2018 • A002

**Application**

Sensor for measuring humidity and temperature in outdoor areas. In delivery condition, the sensor is designed for measuring temperature and relative humidity. Alternatively the output can be set to absolute humidity, enthalpy or dew point. A mounting base for mounting on a level surface and fixing material are included in delivery.

**Types Available**

**Outdoor humidity sensor temperature + humidity – active 2x 0..10 V | 4..20 mA**

FTA54+ VV  
FTA54+ AA

Options: Additional passive temperature sensor (type VVS|AAS)  
eg: PT100/PT1000/NI1000/NI1000TK5000/NTC10K... and other sensors on request.

**Security Advice – Caution**

The installation and assembly of electrical equipment should only be performed by authorized personnel.

The product should only be used for the intended application. Unauthorised modifications are prohibited! The product must not be used in relation with any equipment that in case of a failure may threaten, directly or indirectly, human health or life or result in danger to human beings, animals or assets. Ensure all power is disconnected before installing. Do not connect to live/operating equipment.

Please comply with

- Local laws, health & safety regulations, technical standards and regulations
- Condition of the device at the time of installation, to ensure safe installation
- This data sheet and installation manual

## Notes on Disposal



As a component of a large-scale fixed installation, Thermokon products are intended to be used permanently as part of a building or a structure at a pre-defined and dedicated location, hence the Waste Electrical and Electronic Act (WEEE) is not applicable. However, most of the products may contain valuable materials that should be recycled and not disposed of as domestic waste. Please note the relevant regulations for local disposal.

## Build-up of Self-Heating by Electrical Dissipative Power

Temperature sensors with electronic components always have a dissipative power, which affects the temperature measurement of the ambient air. The dissipation in active temperature sensors shows a linear increase with rising operating voltage. This dissipative power has to be considered when measuring temperature. In case of a fixed operating voltage ( $\pm 0,2$  V) this is normally done by adding or reducing a constant offset value. As Thermokon transducers work with a variable operating voltage, only one operating voltage can be taken into consideration, for reasons of production engineering. Transducers 0..10 V / 4..20 mA have a standard setting at an operating voltage of 24 V =. That means, that at this voltage, the expected measuring error of the output signal will be the least. For other operating voltages, the offset error will be increased by a changing power loss of the sensor electronics. If a re-calibration should become necessary later directly on the sensor, this can be done by means of a trimming potentiometer on the sensor board.

**Remark: Occurring draft leads to a better carrying-off of dissipative power at the sensor. Thus temporally limited fluctuations might occur upon temperature measurement.**

## Application Notice for Humidity Sensors

**Refrain from touching the sensitive humidity sensor/element. Touching the sensitive surface will void warranty.**

For standard environmental conditions re-calibration is recommended once a year to maintain the specified accuracy.

When exposed to high ambient temperature and/or high levels of humidity or presence of aggressive gases (i.e. chlorine, ozone, ammonia) the sensor element may be affected and re-calibration may be required sooner than specified. Re-calibration and deterioration of the humidity sensor due to environmental conditions are not subject of the general warranty.

## Technical Data

<b>Measuring values</b>	temperature, humidity (humidity output configurable)			
<b>Output voltage</b>	<b>VV</b> 2x 0..10 V or 0..5 V, configurable via Jumper, min. load 10 k $\Omega$			
<b>Output ampere</b>	<b>AA</b> 2x 4..20 mA, max. load 500 $\Omega$			
<b>Output passive</b>	<b>VVS   AAS</b> optional, PT100/PT1000/Ni1000/Ni1000TK5000/NTC10K... and other sensors on request			
<b>Power supply</b>	<b>VV</b> 15..24 V = ( $\pm 10\%$ ) or 24 V ~ ( $\pm 10\%$ ) SELV		<b>AA</b> 15..24 V = ( $\pm 10\%$ ) SELV	
<b>Power consumption</b>	<b>VV</b> typ. 0,4 W (24 V =)   0,8 VA (24 V ~)		<b>AA</b> typ. 1 W (24 V =)	
<b>Measuring range temp.</b>	<b>VV   AA</b> adjustable at the transducer: -20..+80   0..+50   -40..+60   -15..+35 $^{\circ}\text{C}$ default setting: -20..+80 $^{\circ}\text{C}$		<b>passive</b> -20..+70 $^{\circ}\text{C}$	
<b>Measuring range humidity</b>	<b>rel. humidity</b> 0..100% rH non-condensing	<b>abs. humidity</b> 0..50   0..80 g/m $^3$ , default setting: 0..50 g/m $^3$	<b>enthalpy</b> 0..85 KJ/kg	<b>dew point</b> 0..50   -20..+80 $^{\circ}\text{C}$ , default: 0..50 $^{\circ}\text{C}$
<b>Accuracy temperature</b>	<b>VV   AA</b> $\pm 0,3$ K (typ. at 21 $^{\circ}\text{C}$ within default measuring range)		<b>passive</b> typ. $\pm 0,3$ K (typ. at 21 $^{\circ}\text{C}$ ), depending on used sensor	
<b>Accuracy humidity</b>	$\pm 2\%$ between 10..90% rH (typ. at 21 $^{\circ}\text{C}$ )			
<b>Enclosure</b>	enclosure USE-M, PC, pure white			
<b>Protection</b>	IP65 according to EN 60529			
<b>Cable entry</b>	Flextherm M16 for cable $\varnothing=3.7$ mm, removable			
<b>Connection electrical</b>	removable plug-in terminal, max. 2,5 mm $^2$			
<b>Filter</b>	stainless steel wire mesh			
<b>Ambient condition</b>	-20..+70 $^{\circ}\text{C}$ , short term condensation			

### Mounting Advices

In case of outdoor installation avoid direct rain and sun contact. Probably use sun respectively rain protection. Cable entry from bottom or side. For side cable routing set loop so that precipitation can drain defined. Observe permissible ambient condition.

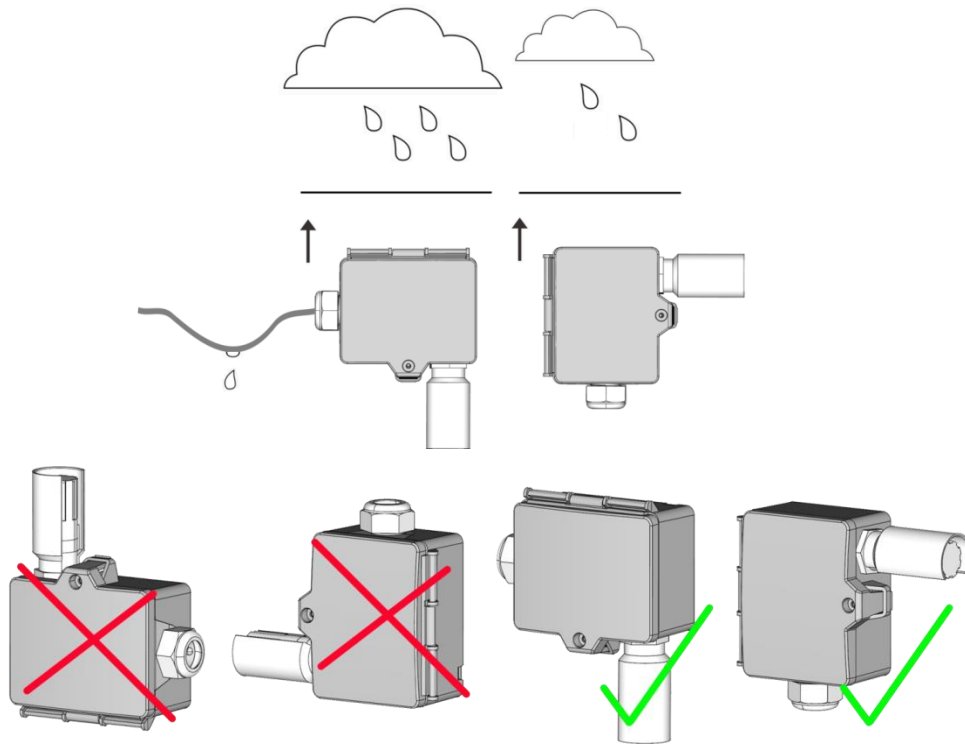

### Connection Plan

VV, VVS  
2x 0..10 V | 0..5 V

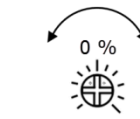
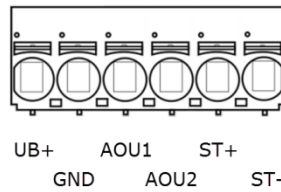
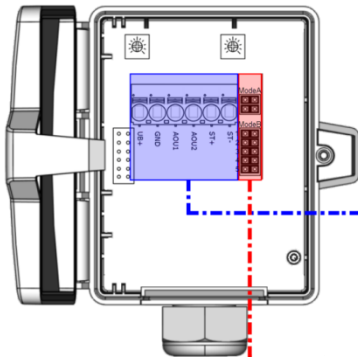

-5 %rH +5 %rH  
absolute humidity: ±3 g/m<sup>3</sup>  
enthalpy: ±3 kJ/kg  
dew point: ±3 K

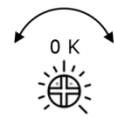

-3 K +3 K  
temperature: (±6°F)

AA, AAS  
2x 4..20 mA

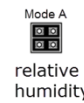
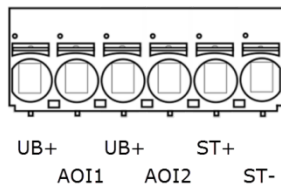
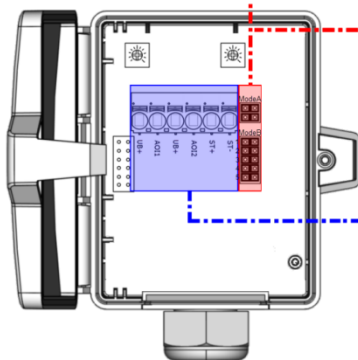

relative humidity



enthalpy

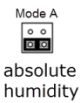

absolute humidity

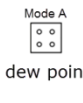

dew point

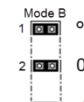

1 °C

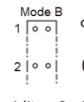

2 0..10 V



3 relative humidity: 0..100%  
absolute humidity: 0..50 g/m<sup>3</sup>  
enthalpy: 0..85 kJ/kg  
dew point: 0..+50 °C  
(+40..+140 °F)



4 relative humidity: 0..100%  
absolute humidity: 0..80 g/m<sup>3</sup>  
enthalpy: 0..85 kJ/kg  
dew point: -20..+80 °C  
(0..+200 °F)

-40..+60 °C  
-40..+160 °F

0..+50 °C  
+40..+140 °F

-20..+80 °C  
0..+200 °F

-15..+35 °C  
0..+100 °F

AO11 | AO1: humidity  
AO12 | AO2: temperature

fig. (Measuring range and offset adjustment, default settings: -20 °C..+80 °C | 0 K)

**Clamp ST+ | ST- : passive Sensor (VVS | AAS)**

The adjustment of the measuring ranges is made by changing the jumpers in a de-energized state. The output value of the new measuring range is available after 2 seconds.

**Note (type FTA54+ AA)**

When only using the temperature output, the humidity output must always be connected to mass/GND of the analog input module.

**Application Notice**

After a certain time, dirt in the air can collect on the filter and then adversely affect the operation of the sensor. Under normal ambient condition an annual maintenance is recommended. Rinse the filter after cleaning with distilled water and dry it using clean oil-free air or nitrogen. Extremely contaminated filters should be replaced. At extreme ambient conditions, e.g. corrosive gases, the humidity sensor may have to be changed.

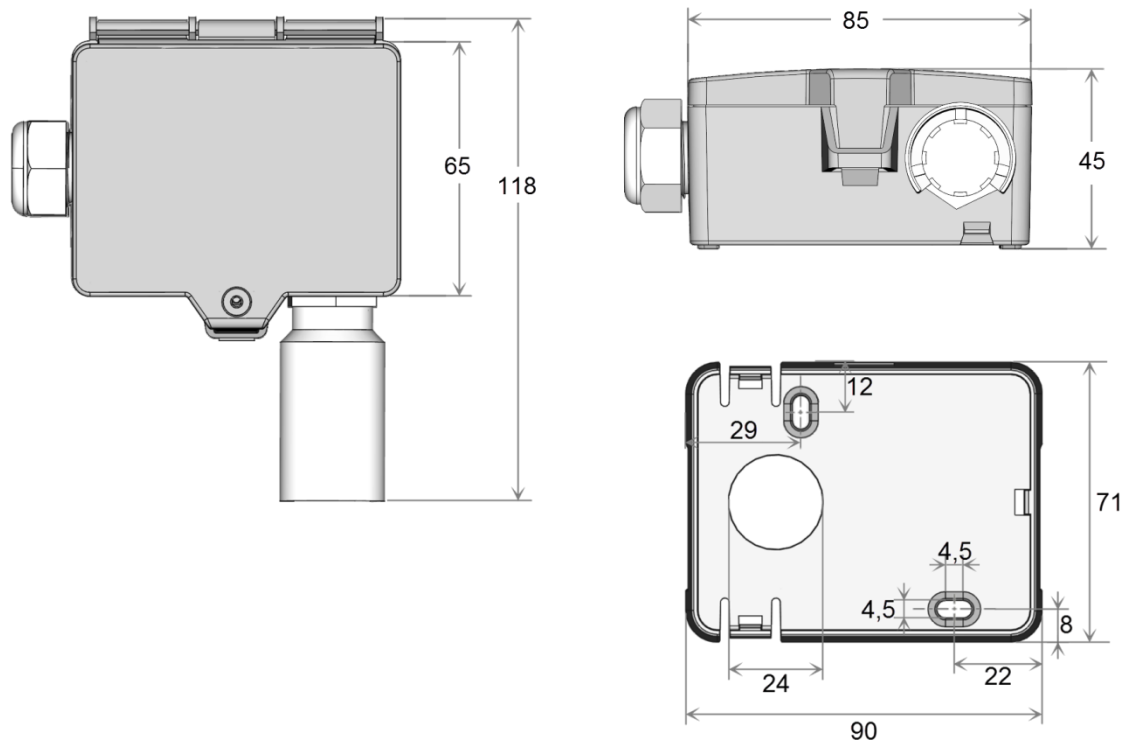
**Dimensions (mm)****Accessories (included in delivery)**

Rain protection	Item No. 670715
Mounting base	Item No. 631228
Mounting kit universal	Item No. 698511
• Cover screw + screw cover • 2 Rawplugs • 2 Screws (countersunk head) • 2 Screws (rounded head)	

**Accessories (optional)**

Cable entry M25 USE white, sealing insert 4x Ø=7 mm (4 pcs)	Item No. 641364
Filter stainless steel, wire mesh	Item No. 231169

**M16 Sealing inserts cable entry (packaging unit 10 pcs.)**

for wire with Ø	8 mm
Item No	641340